

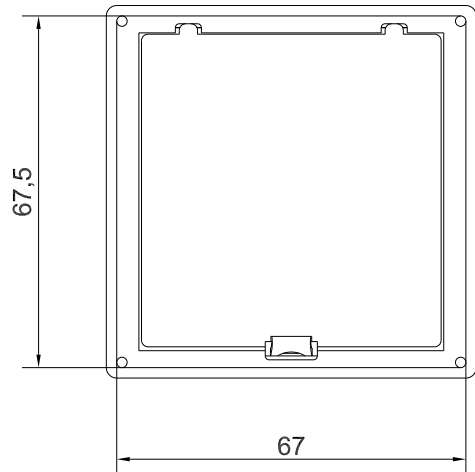

DIMENSION OF PERFORATION

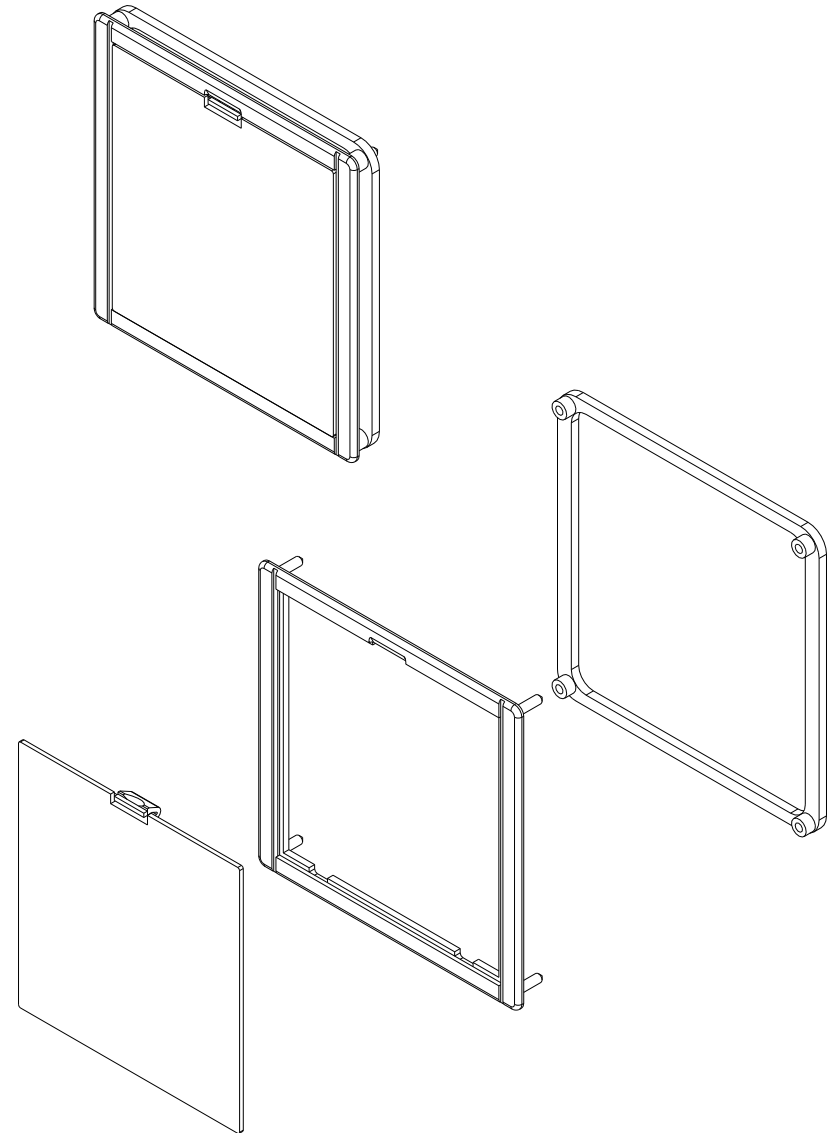

BH-2

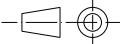

	Denomination	Part. Number		
	Assembly BH-2		BH-2	
	Subject to technical modification without prior notice. Tipographical and other errors do not justify any claim for damages. All dimensions should be verified using an actual moulded part.		Rev. Index	Scale
	This document contains proprietary information of TEKO S.p.a. and is tendered subject to the conditions that the information be retained in confidence not be reproduced or copied and not be used or incorporated in any product.		Date	Format design
		06/05/2005	A3	